

ALU-Craft Cabinet Handles

Architecturally & geometrically crafted handles by CNC machining

Solid aluminium handles & knobs for interior, kitchen, bathroom and more

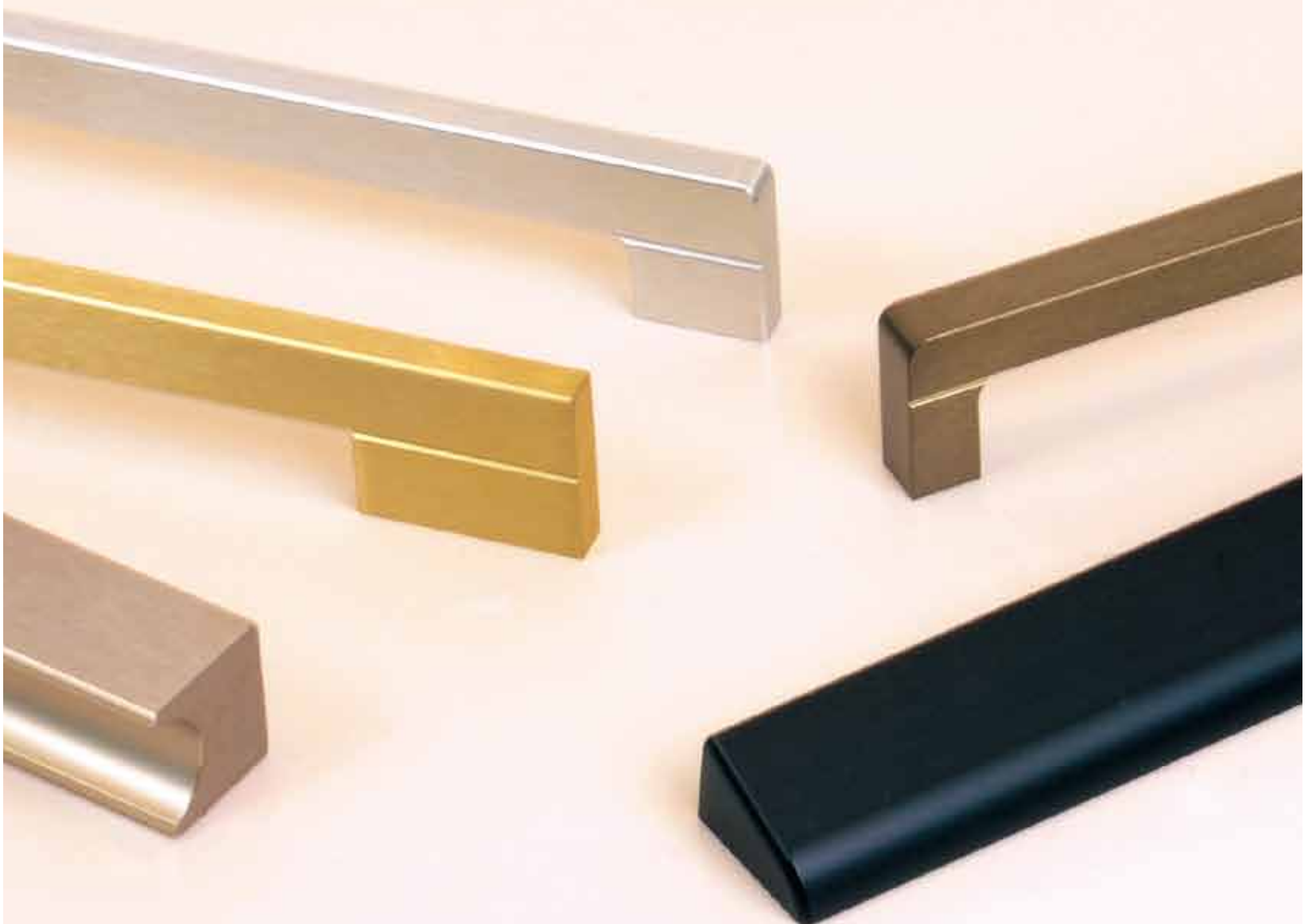

ALU-Craft Cabinet Handles 2020

**High grade aluminium material generates superior quality level of products.*

**CNC machining craft and persistent production management carry out premium cabinet handles.*

**Simplicity in style, streamline in design, clean and healthy way of life.*

Anodized Finishes

Black (NK) & Rustic Iron (DNB)



Hairline Inox (ABN) & Hairline Silver (BNB)



Matt Silver (NA)



Hairline Brass (ABB)



Antique Brass (DAB)

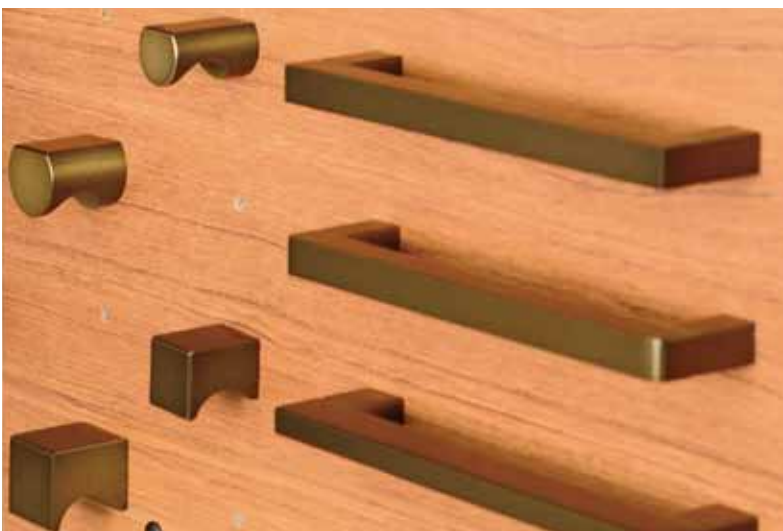

Back-Mounted Aluminium Pull

A8109 with wood screws

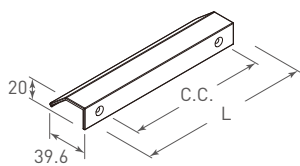

Model No.	C.C.	L.
A8109-42	20	42
A8109-84	64	84
A8109-160	128	160
A8109-320	288	320

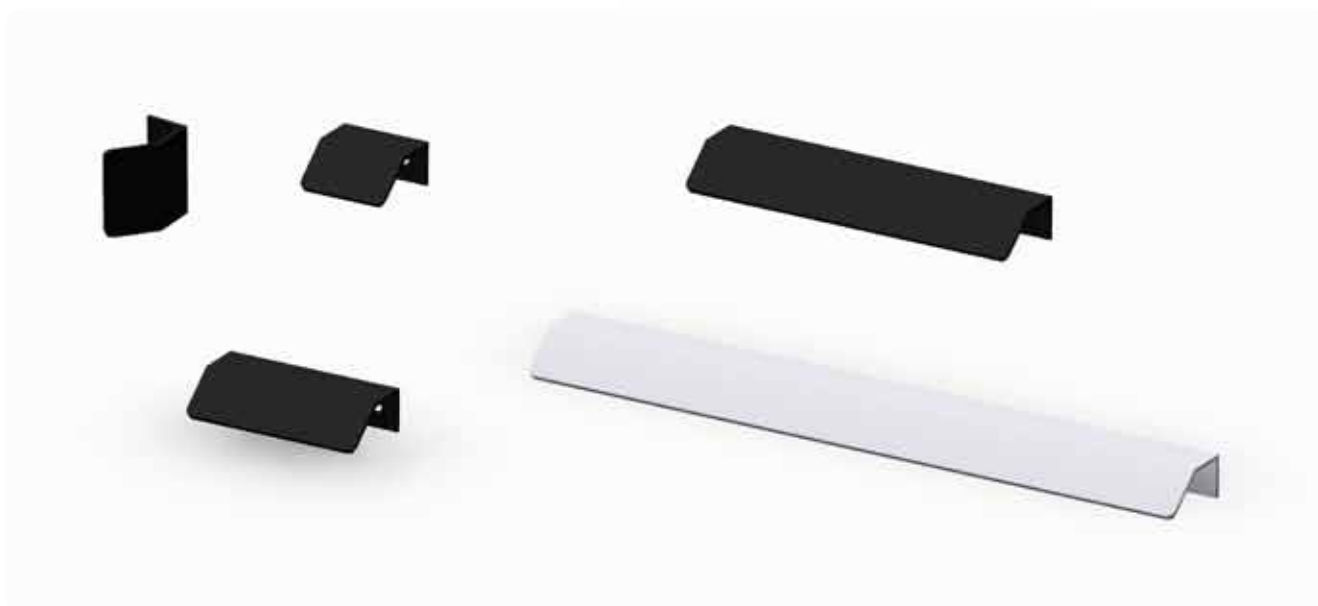
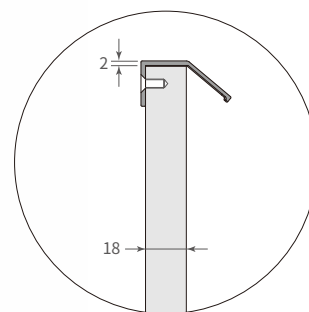
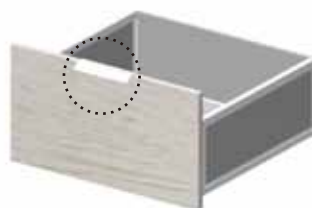

Aluminium Finger Pull

FH18 with 3M adhesive pad

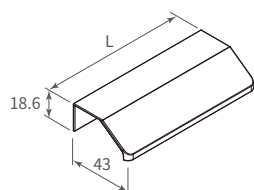

Model No.	L.
FH18-45	45
FH18-90	90
FH18-180	180
FH18-360	360

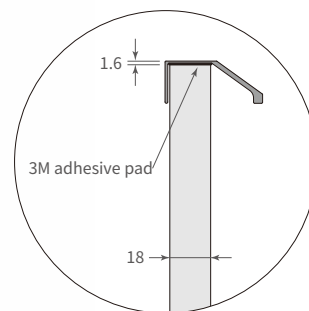

Aluminium Square-U Handle
A3212

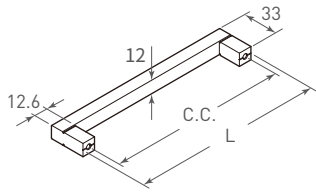

Model No.	C.C.	L.
A3212-160	160	172.6
A3212-224	224	236.6
A3212-352	352	364.6



Aluminium Square-U Handle
A3218

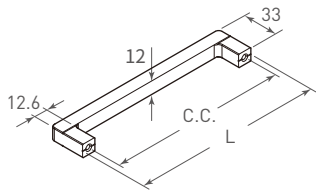

Model No.	C.C.	L.
A3218-160	160	172.6
A3218-224	224	236.6
A3218-352	352	364.6



Aluminium Flat-U Handle

A3226

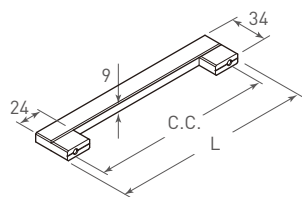

Model No.	C.C.	L.
A3226-160	160	178
A3226-224	224	242
A3226-352	352	370
A3226-480	480	498

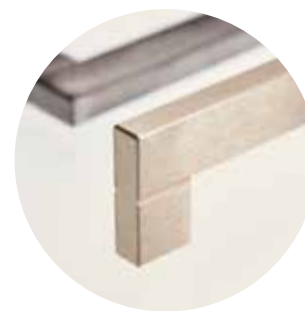

Aluminium Flat-E Handle

A3228

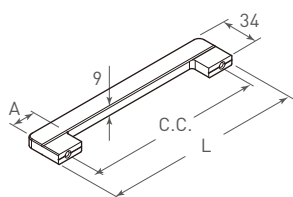

Model No.	C.C.	L.	A
A3228-160	160	180	24
A3228-224	224	244	30
A3228-352	352	372	36



Aluminium Square-E Handle

A3222

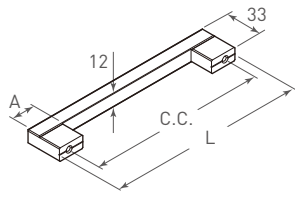

Model No.	C.C.	L.	A
A3222-160	160	180	24
A3222-224	224	244	30
A3222-352	352	372	36



Aluminium Flat-E Handle

A3221

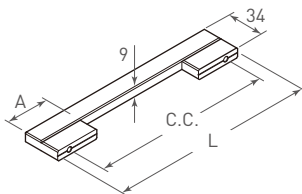

Model No.	C.C.	L.	A
A3221-160	160	180	40
A3221-224	224	244	60
A3221-352	352	372	90
A3221-480	480	500	140

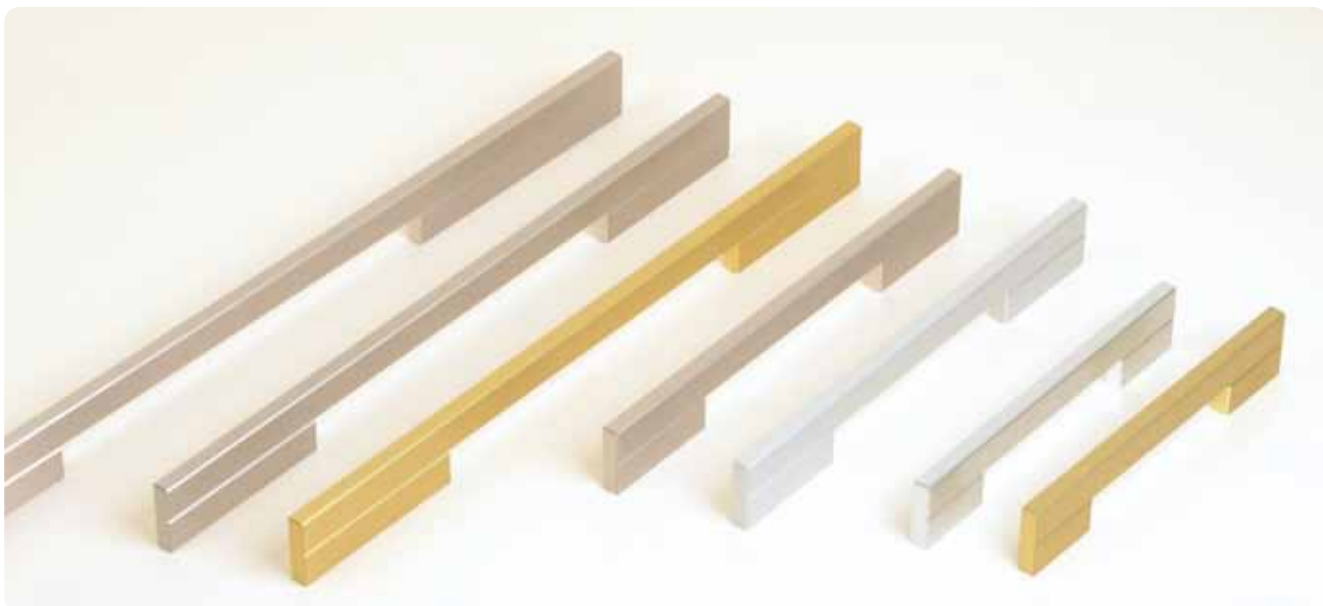
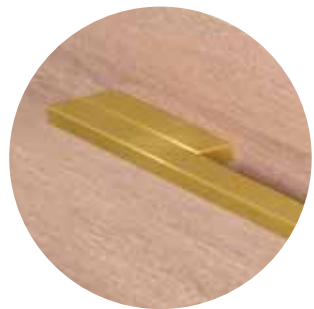

Aluminium Peak-F Handle

A3181

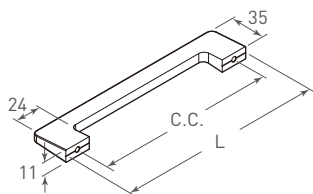

Model No.	C.C.	L.
A3226-160	160	178
A3226-224	224	242
A3226-352	352	370
A3226-480	480	498



Aluminium Eaves Handle

A3551

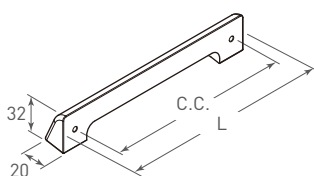

Model No.	C.C.	L.
A3551-96	96	120
A3551-128	128	152
A3551-160	160	184



Aluminium Grip-I Handle

A5141

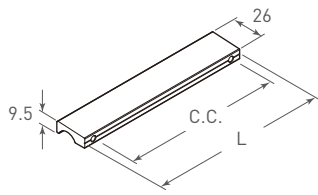

Model No.	C.C.	L.
A5141-32	32	48
A5141-128	128	144
A5141-192	192	208
A5141-288	288	304



Aluminium Grip-C Handle

A5150 series

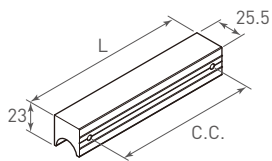

Model No.	C.C.	L.
A5150-32	32	52
A5150-96	96	116
A5150-128	128	148



Aluminium Grip-D Handle
A5151 series

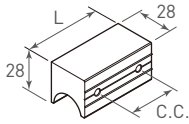

Model No.	C.C.	L.
A5151-32	32	52
A5151-64	64	84

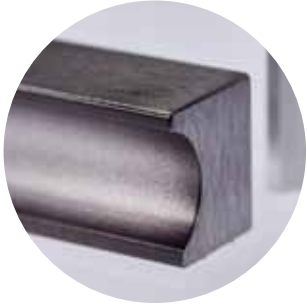

Aluminium Cubic Knob
A5150 & A5151

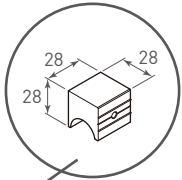
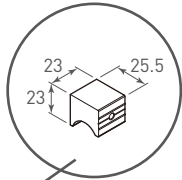

A5150

A5151

Aluminium Di-S Knob

A4422

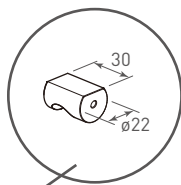

A4422



Aluminium Di-L Knob

A4428

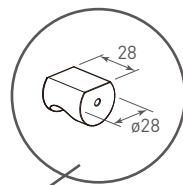

A4428



Aluminium PAD40 Handle

A5161-24

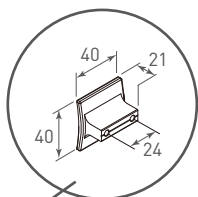

A5161-24



Aluminium PAD64 Handle

A5201-32

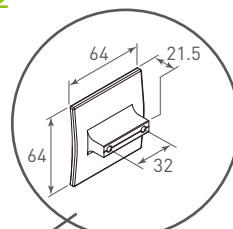

A5201-32





康萊興業股份有限公司
FOUR WINDS CORPORATION

since 1978

11072 台北市基隆路一段176號12樓
12th Fl., No.176, Keelung Rd. Sec.1
Taipei 11072, Taiwan

T +886-2-2768-8389
F +886-2-2768-7955~7
E fw@fourwinds.com.tw